

Introduction

General

R8800 series digital heating thermostat, using the most advanced micro-computerized control chip, detecting room temperature through internal or external NTC. By comparing with setting temperature, it can automatically open/close heating equipment, so as to keep room temperature constant. You can set 6 or 4 time periods and the corresponding temperature, and can choose manual control or temporary manual control. With special dual-temperature and dual-control function, it detects not only room temperature but also heating equipment temperature, when heating equipment temperature is higher than setting temperature, thermostat will stop heating automatically to protect heating equipment; when room temperature is lower than setting temperature, it will open heating equipment, let it work in reasonable environment and prolong life, making system more safe, reliable and energy-saving.

Mode Definition

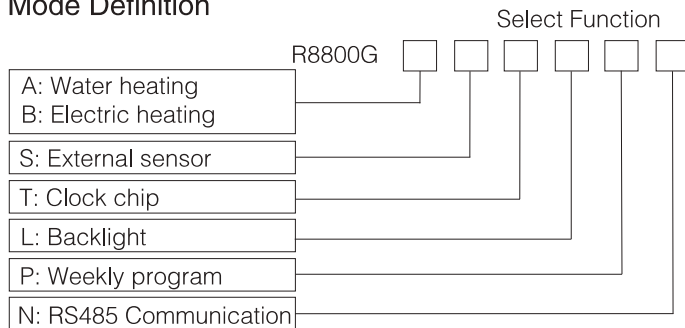



Technical Data

Consumption: < 1.5W
 Timing Error: < 1%
 Power Supply: 100VAC-240VAC 50/60HZ
 Load Current: GA:2A GB:16A
 Temperature Range: 5°C-35°C Accuracy: ± 1°C
 Dimension: 94mm X 87mm X 18mm (Overall thickness 44mm)

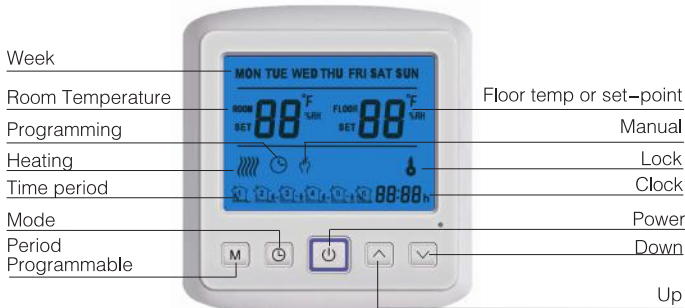
Function and Display





: Manual control. Under manual mode, it can manually set according to the current temperature to control heating equipment.

: Programming mode. Thermostat will run automatically according to the setting times and temperature. Programming can be divided into two cycles a week, day "12345" and day "67", 5 + 2 programming mode, each mode has six time periods and six temperature setting.

- : Period 1, morning get up
- : Period 2, morning out
- : Period 3, noon home
- : Period 4, noon out
- : Period 5, night home
- : Period 6, night sleeping

: Temporary manual mode. Under the programming mode, you can switch to the temporary state, when the next time period come, it will automatically switch to programming control state. (Temporary manual mode can not save the temperature setting), Press "M" key to switch to manual mode.

: Indicated key locked, Press the "∧" "∨" button for more than 5 seconds to thermostat panel, and press for more than 5 seconds to unlock.

: Indicated being heated, When it flashes, it means the temperature of heat source exceed the maximum limit, Load cut off. In the off state, if you open the frost protection and open load, the icon is also displayed.

FLOOR: Indicated the floor temperature, it will be displayed only have internal and external sensors, when select "AL" sensor type in the advanced options, press "∧" button long time, it returns to the previous display after losing the button 3 seconds. (Optional: only the double-sensor configuration)

Operation

"⏻" Power, turn-on/off. In the open state, LCD screen bright up, thermostat will run according to the current work mode: manual mode, programming mode and temporary manual mode. In the off state, LCD screen without any display, save the work status before turning off and set parameters.

"M" Mode, manual and programming mode changeover.

Under communication mode, this key is unavailable.

"⌚" Clock, Short press this button to adjust the clock, adjusting order: minute adjustment → hour adjustment → week adjustment → return to original status, press "⌚" key to switch respectively. Long press "⌚" key for 3 sec. to enter into programming mode, adjusting order: Monday~Friday first time zone adjusting → Monday~Friday first time zone setting Temp adjusting → ...







→ Saturday and Sunday sixth time zone adjusting → Saturday and Sunday sixth time zone setting Temp adjusting (see below schedule). Each parameter set up and press "⌚" key to switch to the next parameter setting, to set the parameters by flashing, press "∧", "∨" button to adjust (Time to increase or decrease in the unit of every 15).

"∨" Temperature down or adjust working mode

"∧" Temperature up or adjust working mode

Return function: After power off for 20 sec. press M, ⌚, ∧ and ∨ for 5 sec. at the same time, then LCD Screen will display all the icons. And week programmable and high senior setting will return to the factory set.

Factory default setting of period setting time and temperature

Time display	Weekday (Mon-Fri)		Weekend (Mon-Fri)	
	time	temperature	time	temperature
	06:00 get up	20°C	06:00 get up	20°C
	08:00 work	15°C	08:00 out	20°C
	11:30 afternoon rest	15°C	11:30 afternoon rest	20°C
	13:30 work	15°C	13:30 out	20°C
	17:00 off work	22°C	17:00 go homek	20°C
	22:00 rest	15°C	22:00 rest	15°C

Senior parameter option

During power off, press “M” and “⊖” for 5sec, enter into senior setting. It includes temperature correction, sensor choosing, dead-zone, low temperature protection, overheating protection, weekend choosing, locking, 485 Communications IP high and low. Then press “M” to changeover to the relative item. At last, confirm it and turn on automatically.

Code	Option	“∨” OR “^”
1.	Temperature compensation in internal sensor	-9°C ~ +9°C
2.	Deadzone Temperature	1 ~ 5°C. When the setting temperature is equal to or more than room temperature plus deadzone temperature, heating equipment open. When room temperature is equal to or more than temperature plus deadzone temperature, heating equipment close. Take an example, Providing deazone temperature is 2°C and setting temperature is 25°C, when room temperature is 25°C, heating equipment close, when room temperature decrease to 23°C, heating equipment open.
3.	Sensor types	IN: Internal Sensor (to control and protect the temperature) OU: External Sensor (to control and protect the temperature) AL: Internal/ External Sensor (Internal sensor is for room temperature controlling, external sensor is for temperature protection.) Remark: Please make sure the right sensor. If choose the wrong or bad one, LCD will display Err, the thermostat will stop working until emilinating the failure.
4.	Low temperature protection setting.	5-10°C. When up to Max. 10°C, press ^ . When display “- -” , cancel this function. If the detecting temperature is lower then the low temperature protection setting, heating equipment will be forced to open.
5.	High temperature protection setting.	35-70°C. When down to Min. 35°C, press ∨ . When display “- -” , cancel this function. If detecting temperature is higher than the high temperature protection setting, heating equipment will be forced to close.
6.	Button locking	0: Buttons are locked except Power button. 1: All buttons are locked.
7. ⁽¹⁾	Weekend setting (Optional)	Two-day Weekend: 12345 and 67 One-day Weekend: 123456 and 7 --: Cancel weekly programming
8. ⁽²⁾	485 Communication IP high address (Optional)	00-FF
9. ⁽²⁾	485 Communication IP Low address (Optional)	01-FF

Note: (1) This option is not included for N series product

(2) This option is not included for P series product

Installation

1.

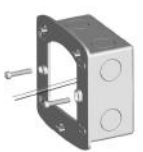

Use screws (provided) to fasten the back cover of LCD Display unit on wall or box.

2.



The Power unit should be connected to the Control Display according to the wiring diagram

3.



The cover of LCD Display unit is connected on the wall or box at the angle of 30° . Turn down the screwdriver with a little pressure, and open the LCD unit.

4.



Finished.

Wiring

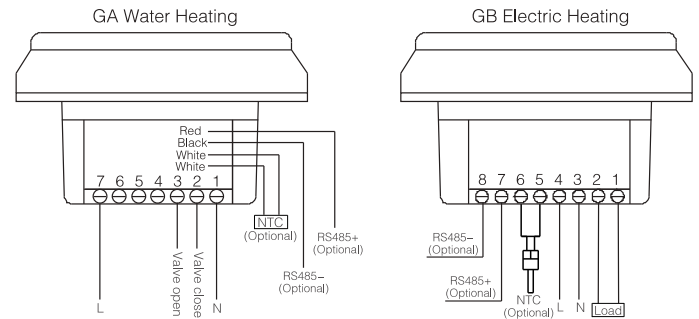

Note:

- ★ Please strictly follow the installation wiring diagram for wiring;
- ★ Please strictly follow the installation diagram for proper installation;
- ★ Do not pull cable, otherwise it will cause damage;
- ★ During the installation process be careful not to put pressure on the LCD, or LCD surface scratch;
- ★ During the installation process be careful not to bump circuit board components, do not fall or make the board after the shell deformation;
- ★ During the installation process if the use of hard plastic line, it must first be an appropriate point of bending;
- ★ Do not fall into the slurry.

Simple exception handling:

Note: The maintenance of this company's products is limited to professional and technical personnel.

phenomenon exception handling:	Handlin
Power but no display	<ul style="list-style-type: none"> ★ Check the L, N power supply is normal, the reliability of wiring; ★ Check the switch is flexible and efficient; ★ First replace the control panel, and then replace the power board; ★ LCD motherboard and drive cable between the power board is loose;
LCD Garbled	<ul style="list-style-type: none"> ★ After installation, the shell deformation, loose one or two fixed screws;
Shows normal but no Output	<ul style="list-style-type: none"> ★ Control board and power board connected to cable damage; ★ First replace the control panel, then replace the power supply board;
Remote malfunction	<ul style="list-style-type: none"> ★ Temperature is not calibrated, through the panel directly to calibrate the temperature
Temperature display is not normal	<ul style="list-style-type: none"> ★ Check whether the remote control battery power; ★ Replacement remote control;

Warranty

We offer the warranty of 18 months, from the sales day. If it is not the quality problems, or beyond the warranty period, we will charge for the after-sale service.